

WTO

QuickFlex®

Das neue Schnellwechsel-Werkzeugsystem für hohe Performance und Präzision.

Minimale Investition, maximale Flexibilität.



Adapter
Programm

QuickFlex®

Minimale Investition, maximale Flexibilität.

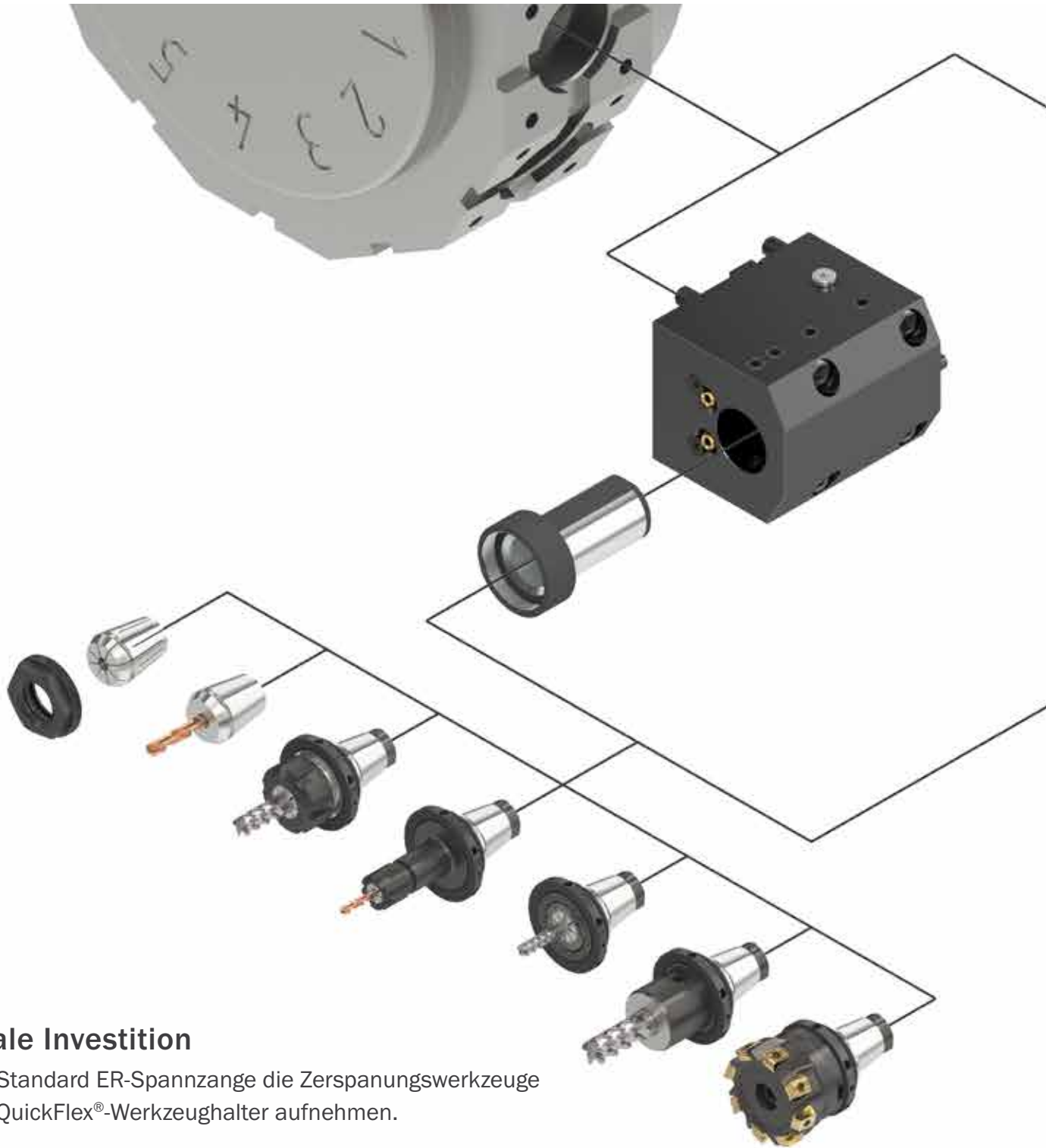

Minimale Investition

Mit einer Standard ER-Spannzange die Zerspanungswerkzeuge direkt im QuickFlex®-Werkzeughalter aufnehmen.

Maximale Flexibilität

Je nach Bedarf QuickFlex®-Adapter anschaffen und flexibel zum Schnellwechselsystem erweitern, um Rüstzeiten zu reduzieren.

Für Drehzentren mit Revolverantrieb steht ein umfangreiches QuickFlex®-Programm mit Adaptern für alle gängigen Werkzeugaufnahmen zur Verfügung.

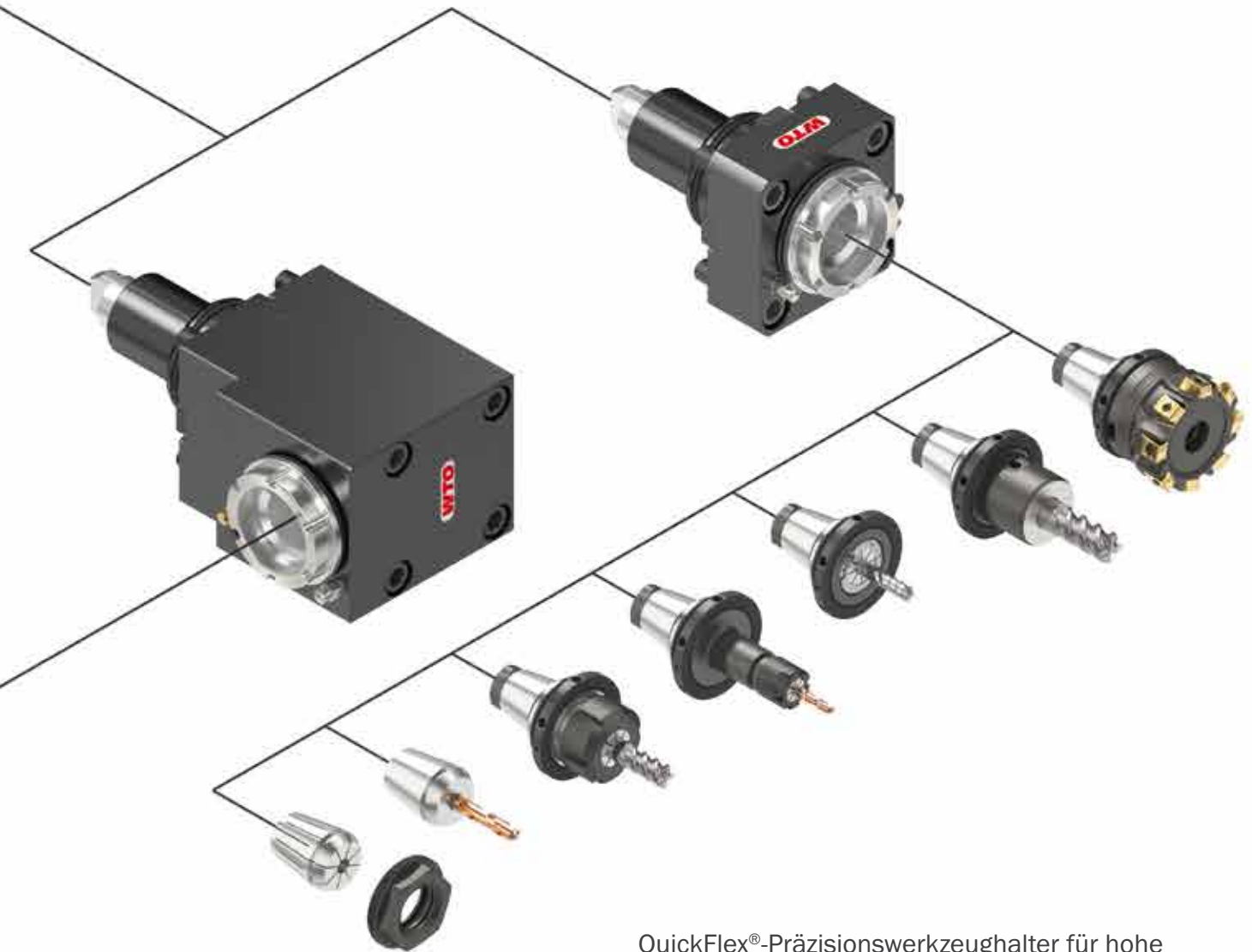

QuickFlex®-Präzisionswerkzeughalter für hohe Performance und Präzision Ihres Drehzentrums.



QuickFlex®

Die optimale Kombination aus ER-Spannzangenaufnahme und Wechselsystem in einem Werkzeughalter.



- 1 - Werkzeughalter
- 2 - QuickFlex®-Aufnahme
- 3 - Spannzange
- 4 - Spannzangenmutter
- 5 - QuickFlex®-Adapter
- 6 - Einhandbedienschlüssel (patentiert)
- 7 - Gewinde für QuickFlex®-Adapter und Spannzangenmutter
- 8 - Kurzkegelaufnahme zur radialen Zentrierung und axialen Abstüzung der QuickFlex®-Adapter
- 9 - Kegelaufnahme für ER-Spannzangen
- 10 - Drehmomentmitnahme für QuickFlex®-Adapter
- 11 - Radiale Abstüzung der QuickFlex®-Adapter für hohe Steifigkeit unter Last

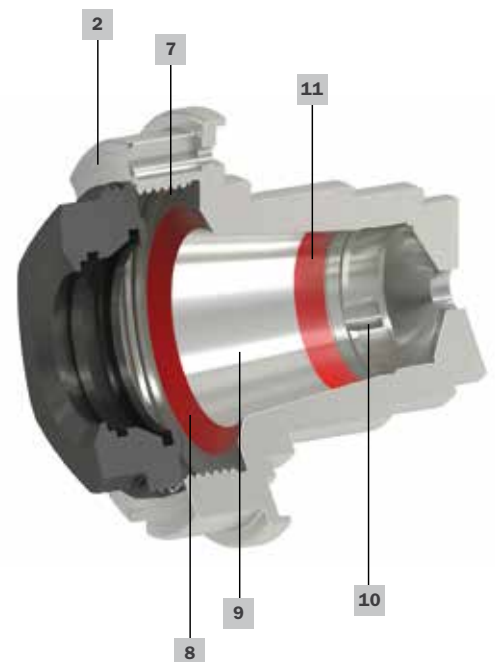

Dauerhaft hohe Rundlaufgenauigkeit garantieren
zwei voneinander unabhängige Kegelaufnahmen.

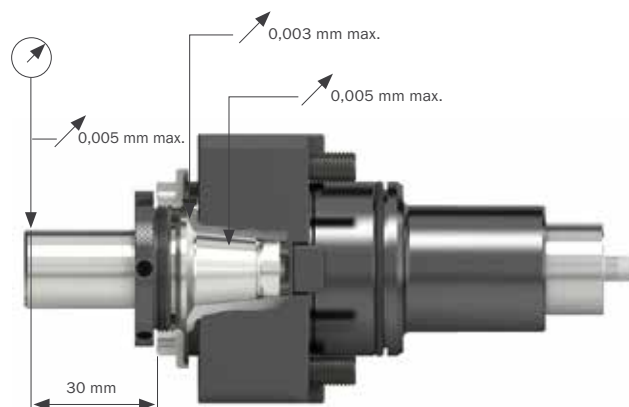
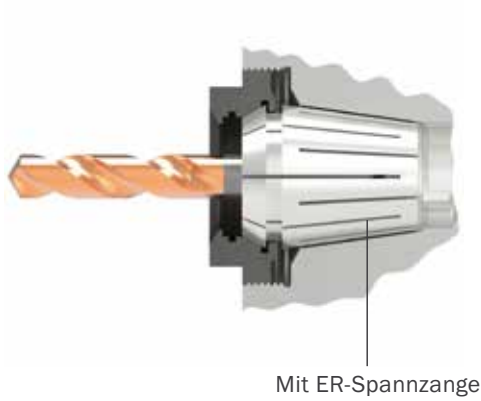

Schneller und sicher mit dem
patentierten Einhandbedienschlüssel.



Zylinderschaftaufnahme

mit zylindrischem Schaft und seitlicher Klemmfläche.

Zum flexiblen Einsatz von QuickFlex®-Adaptern in Bohrstangenhaltern.

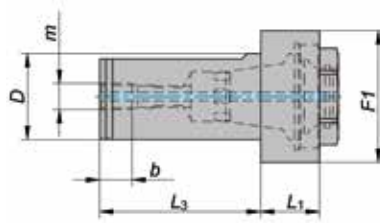

Größe	Bestellnummer	D	d min.	d max.	L ₃	F ₁	L ₁	m	b	
ER-25QF	330025032	32	1	16	60	49	22	G $\frac{1}{8}$ "	12	107525020
ER-32QF	330032040	40	2	20	70	58	22	G $\frac{1}{4}$ "	15	107532020
ER-40QF	330040050	50	3	26	80	71	22	G $\frac{3}{8}$ "	19	107540020

Abmessungen in mm

Starterset



Größe	Bestellnummer	 Einhand- bedienschlüssel	 Spannschlüssel für QuickFlex®	 Weldon/Whistle- Notch Adapter	 Kombi- Fräsdornadapter	 Spannzangen- adapter	 Spannschlüssel
ER-20QF	007020000	107720000	107520020	Ø 12 mm	Ø 16 mm	ER 20	107520000
ER-25QF ¹⁾	007025000	107725000	107525020	Ø 16 mm	Ø 16 mm	ER 25	107525000
ER-25QF ¹⁾	007025010	107725010	107525020	Ø 16 mm	Ø 16 mm	ER 25	107525000
ER-32QF	007032000	107732000	107532020	Ø 20 mm	Ø 22 mm	ER 32	107532000
ER-40QF	007040000	107740000	107540020	Ø 25 mm	Ø 27 mm	ER 40	107540000
ER-50QF	007050000	107750000	107550020	Ø 25 mm	Ø 27 mm	ER 40	107540000



Abmessungen in mm

¹⁾ Bei der Bestellung das zum Werkzeughalter passende Starterset anfragen

Spannzangenadapter

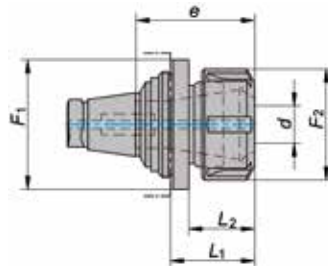
DIN 6499, ISO 15488







Größe	Bestellnummer	F ₁	d min.	d max.	F ₂	e	L ₂	L ₁	Größe Zange		
ER-20QF	320020010	36	0,5	10	28	40	23	29	ER 16	200016000	107516000
	320020013	36	1	13	34	45	24	30	ER 20	200020000	107520000
ER-25QF	320025010	49	0,5	10	28	40	23	30	ER 16	200016000	107516000
	320025013	49	1	13	34	45	24	31	ER 20	200020000	107520000
	320025016	49	1	16	42	48	25	32	ER 25	200025000	107525000
ER-32QF	320032013	58	1	13	34	45	24	31	ER 20	200020000	107520000
	320032016	58	1	16	42	48	25	32	ER 25	200025000	107525000
	320032020	58	2	20	50	50	28	35	ER 32	200032000	107532000
ER-40QF	320040016	71	1	16	42	48	25	33	ER 25	200025000	107525000
	320040020	71	2	20	50	50	28	36	ER 32	200032000	107532000
	320040026	71	3	26	63	55	35	43	ER 40	200040000	107540000
ER-50QF	320050020	82	2	20	50	50	28	37	ER 32	200032000	107532000
	320050026	82	3	26	63	55	35	44	ER 40	200040000	107540000

Abmessungen in mm

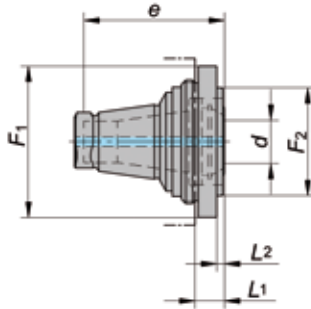
Spannzangenadapter kurz

DIN 6499, ISO 15488





Größe	Bestellnummer	F ₁	d min.	d max.	F ₂	e	L ₂	L ₁	Größe Zange			
ER-20QF	320020007-09	36	0,5	7	-	36	-	6	ER 11	200111001	107511101	-
ER-25QF	320025010-07	49	0,5	10	-	40	-	7	ER 16	200116001	107516101	-
	320025013-09	49	1	13	35	45	2	9	ER 20	200120001	107520101	-
ER-32QF	320032013-07	58	1	13	-	45	-	7	ER 20	200120001	107520101	-
	320032016-07	58	1	16	-	48	-	7	ER 25	200125001	107525101	107525104
ER-40QF	320040016-08	71	1	16	-	48	-	8	ER 25	200125001	107525101	107525104
	320040020-08	71	2	20	-	50	-	8	ER 32	200132001	107532101	107532104
ER-50QF	320050020-09	82	2	20	-	50	-	9	ER 32	200132001	107532101	107532104
	320050026-09	82	3	26	-	56	-	9	ER 40	200140001	107540101	107540104

Abmessungen in mm

Spannzangenadapter lang

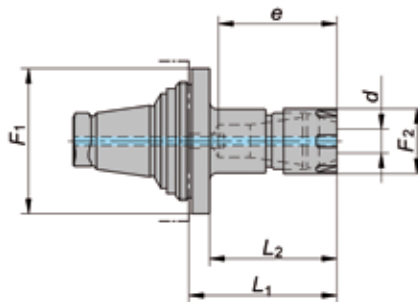
DIN 6499, ISO 15488





Größe	Bestellnummer	F ₁	d min.	d max.	F ₂	e	L ₂	L ₁	Größe Zange		
ER-20QF	320020007-40	36	0,5	7	16	36	34	40	ER 11	200511000	107511005
ER-25QF	320025007-40	49	0,5	7	16	36	33	40	ER 11	200511000	107511005
	320025010-50	49	0,5	10	22	40	43	50	ER 16	200516000	107516005
ER-32QF	320032007-50	58	0,5	7	16	36	43	50	ER 11	200511000	107511005
	320032010-60	58	0,5	10	22	40	53	60	ER 16	200516000	107516005
ER-40QF	320040010-60	71	0,5	10	22	40	52	60	ER 16	200516000	107516005
	320040016-60	71	1	16	35	48	52	60	ER 25	200525000	107525005

Abmessungen in mm

Weldon/WhistleNotch Adapter

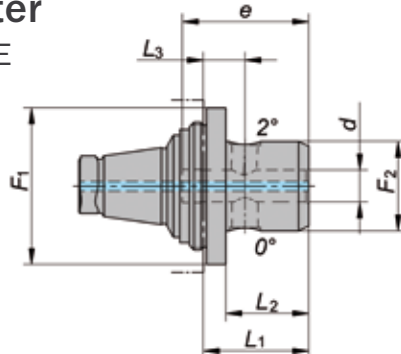
für Schäfte nach DIN 6535-HB und -HE



Größe	Bestellnummer	F ₁	d	F ₂	L ₃	e	L ₂	L ₁		
ER-20QF	320120006	36	6	19	10	36	22	28	12882	26071
	320120008	36	8	21	11	36	23	29	12927	26072
	320120010	36	10	28	12	40	26	32	12992	26073
	320120012	36	12	34	14,5	45	31	37	13061	26074
	320120014	36	14	36	15,5	45	32	38	13061	26074
	320120016	36	16	38	18	49	36	42	30944	26075
ER-25QF	320125006	49	6	19	11	36	22	29	12882	26071
	320125008	49	8	21	12	36	23	30	12927	26072
	320125010	49	10	28	13	40	26	33	12992	26073
	320125012	49	12	34	13,5	45	29	36	13061	26074
	320125014	49	14	36	13,5	45	29	36	13061	26074
	320125016	49	16	38	16	49	33	40	30944	26075
	320125018	49	18	40	16	49	33	40	30944	26075
	320125020	49	20	45	18	51	36	43	106290	26076
ER-32QF	320132006	58	6	19	11	36	22	29	12882	26071
	320132008	58	8	21	12	36	23	30	12927	26072
	320132010	58	10	28	13	40	26	33	12992	26073
	320132012	58	12	34	13,5	45	29	36	13061	26074
	320132014	58	14	36	13,5	45	29	36	13061	26074
	320132016	58	16	38	16	49	33	40	30944	26075
	320132018	58	18	40	16	49	33	40	30944	26075
	320132020	58	20	45	17	51	35	42	106290	26076
	320132025	58	25	51	22	57	39	46	13128	26076
	ER-40QF	320140006	71	6	19	12	36	22	30	12882
320140008		71	8	21	13	36	23	31	12927	26072
320140010		71	10	28	14	40	26	34	12992	26073
320140012		71	12	34	14,5	45	29	37	13061	26074
320140014		71	14	36	14,5	45	29	37	13061	26074
320140016		71	16	38	17	49	33	41	30944	26075
320140018		71	18	40	17	49	33	41	30944	26075
320140020		71	20	45	18	51	35	43	106290	26076
320140025		71	25	51	18	57	34	42	13128	26076
ER-50QF		320150006	82	6	19	13	36	22	31	12882
	320150008	82	8	21	14	36	23	32	12927	26072
	320150010	82	10	28	15	40	26	35	12992	26073
	320150012	82	12	34	15,5	45	29	38	13061	26074
	320150014	82	14	36	15,5	45	29	38	13061	26074
	320150016	82	16	38	18	49	33	42	30944	26075
	320150018	82	18	40	18	49	33	42	30944	26075
	320150020	82	20	45	19	51	35	44	106290	26076
	320150025	82	25	51	19	57	34	43	13128	26076
	320150032	82	32	72	23	61	38	47	71255	26077

Abmessungen in mm

Kombi-Fräsdornadapter für Planfräser und Scheibenfräser

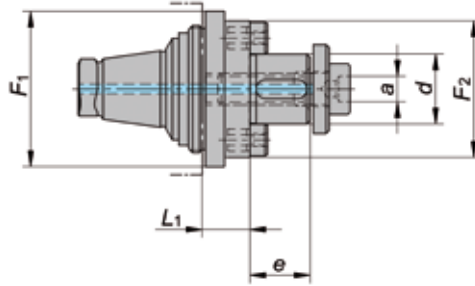

Größe	Bestellnummer	F ₁	d	F ₂	e	L ₁	a			
ER-20QF	320220016	36	16	35	17	12	6	84130	84903	26075
ER-25QF	320225016	49	16	35	17	8	6	84130	84903	26075
	320225022	49	22	43	19	15	8	84131	84904	26076
	320225027	49	27	50	21	15	10	84132	84905	26077
ER-32QF	320232016	58	16	35	17	8	6	84130	84903	26075
	320232022	58	22	43	19	8	8	84131	84904	26076
	320232027	58	27	50	21	15	10	84132	84905	26077
ER-40QF	320240022	71	22	43	19	9	8	84131	84904	26076
	320240027	71	27	53	21	9	10	84132	84905	26077
	320240032	71	32	63	24	20	14	84133	84906	26078
ER-50QF	320250022	82	22	43	19	10	8	84131	84904	26076
	320250027	82	27	53	21	10	10	84132	84905	26077
	320250032	82	32	61	24	10	14	84133	84906	26078

Abmessungen in mm

Universelles Design:
Passfeder und Mitnahmebolzen können entfernt werden.

Alle Adapter werden mit Standard Fräseranzugsschraube ohne Kühlmittelbohrung geliefert.

Optionale Fräseranzugsschraube mit Kühlmittelbohrung für interne Kühlmittelzufuhr

d		
16	84841	26075
22	84842	26076
27	84843	26077
32	84844	26078

Abmessungen in mm

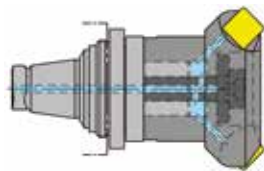

Hydrodehnadapter

für Zylinderschäfte

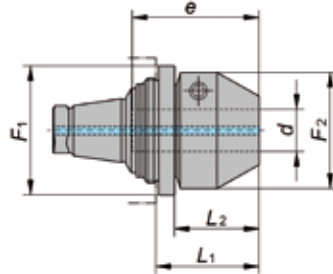

Größe	Bestellnummer	F ₁	d	F ₂	e	L ₂	L ₁		Nm	 (inkl. Klinge)	 Klinge
ER-25QF	320425016	49	16	44	48	32	39	3	5	STW-T-W3-A	118077
ER-32QF	320432020	58	20	52	53	31	38	4	10	STW-T-W4-A	118078
ER-40QF	320440025	71	25	59	58	31	39	4	10	STW-T-W4-A	118078

Maximales Anzugsmoment in Nm beachten! Abmessungen in mm

Reduzierhülsen für Hydrodehn

geschlitzt

mit Abdichtung für IK

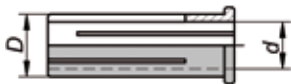

d	D16	D20	D25
2	244016002	244020002	-
3	244016003	244020003	244025003
4	244016004	244020004	244025004
5	244016005	244020005	244025005
6	244016006	244020006	244025006
7	244016007	244020007	244025007
8	244016008	244020008	244025008
9	244016009	244020009	244025009
10	244016010	244020010	244025010
12	244016012	244020012	244025012
14	244016014	244020014	244025014
16	-	244020016	244025016
18	-	-	244025018
20	-	-	244025020
22	-	-	244025022

Abmessungen in mm

d	D16	D20	D25
2	-	-	-
3	244116003	244120003	244125003
4	244116004	244120004	244125004
5	244116005	244120005	244125005
6	244116006	244120006	244125006
7	244116007	244120007	244125007
8	244116008	244120008	244125008
9	244116009	244120009	244125009
10	244116010	244120010	244125010
12	244116012	244120012	244125012
14	244116014	244120014	244125014
16	-	244120016	244125016
18	-	-	244125018
20	-	-	244125020
22	-	-	244125022

Abmessungen in mm

powRgrip® Spannzangenadapter

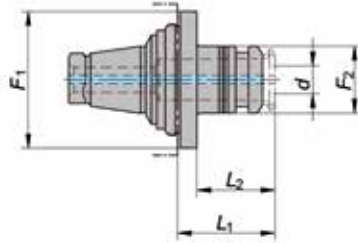

Größe	Bestellnummer	F ₁	d min.	d max.	F ₂	L ₁	L ₂	Größe Zange
ER-20QF	325220P15	36	3	10	24	34	28	PGST 15
ER-25QF	325225P15	49	3	10	24	35	28	PGST 15
ER-32QF	325232P25	58	3	20	40	47	40	PGST 25
ER-40QF	325240P25	71	3	20	40	48	40	PGST 25

Abmessungen in mm

powRgrip® Spannzangen PGST

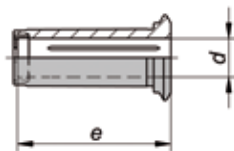

Das powRgrip®-System besteht aus:

- | Hochpräziser powRgrip®-Spannzange
- | QuickFlex®-Adapter für powRgrip®-Spannzange
- | powRgrip®-Spanneinheit (PGU/PGC)
(automatisch oder manuell)

d	e	PGST	WTO Bestellnummer	REGO-FIX Bestellnummer
3	28	PGST 15	244P15003	1715.03006
4	28	PGST 15	244P15004	1715.04006
6	36	PGST 15	244P15006	1715.06006
8	36	PGST 15	244P15008	1715.08006
10	40	PGST 15	244P15010	1715.10006
3	28	PGST 25	244P25003	1725.03006
4	28	PGST 25	244P25004	1725.04006
6	36	PGST 25	244P25006	1725.06006
8	36	PGST 25	244P25008	1725.08006
10	40	PGST 25	244P25010	1725.10006
12	45	PGST 25	244P25012	1725.12006
16	48	PGST 25	244P25016	1725.16006
20	48	PGST 25	244P25020	1725.20006

Abmessungen in mm



Schneidwerkzeug



REGO-FIX powRgrip®-Spannzange





QuickFlex®-Adapter für
REGO-FIX powRgrip®

Mini-Pendeladapter MPHC

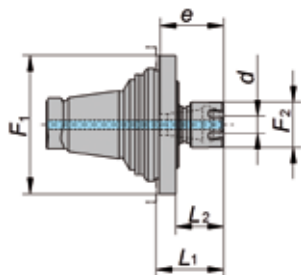
DIN 6499, ISO 15488



Größe	Bestellnummer	F ₁	d min.	d max.	F ₂	e	L ₂	L ₁	Größe Zange		
ER-25QF	325325M11	49	0,5	7	16	22,5	17	24	ER 11	200511000	107511005
ER-32QF	325332M16	58	0,5	10	22	33	33	26	ER 16	200516000	107516005

Abmessungen in mm

Probleme, die beim Reiben durch Achsversatz auftreten können:



Bohrung wird zu groß



Konische Bohrung
(Eingang zu groß)



Konische Bohrung
(Ende zu groß)



Reibahle klemmt und bricht



Schlechte Oberflächengüte



Bohrung zeigt
Rattermarken oder Riefen

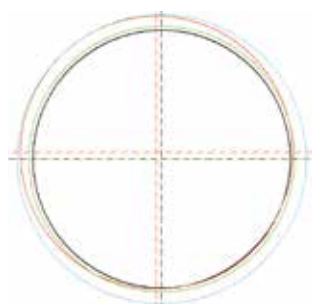



Achsversatz

Adapter für BIG KAISER

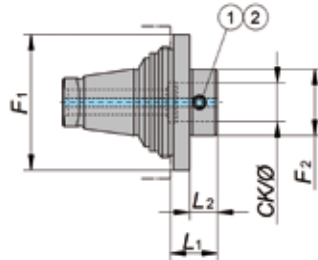
für Ausdrehwerkzeuge der Größen CBK1 bis CBK4



Größe	Bestellnummer	CK/Ø	F1	F2	L1	L2	 ①	 ②
ER-25QF	325125CK1	CKB1/11	49	19	15,5	8,5	103828	26079
	325125CK3	CKB3/18	49	31	19,5	12,5	72733	26072
ER-32QF	325132CK1	CKB1/11	58	19	15,5	8,5	103828	26079
	325132CK3	CKB3/18	58	31	19,5	12,5	72733	26072
ER-40QF	325140CK2	CKB2/14	71	24	18	10	69040	26071
	325140CK4	CKB4/22	71	39	23	15	67821	26073
ER-50QF	325150CK2	CKB2/14	82	24	19	10	69040	26071
	325150CK4	CKB4/22	82	39	24	15	67821	26073

Abmessungen in mm

Werkzeugkombinationen und Bearbeitungsdurchmesser

Detaillierte Spezifikationen über Ausdrehwerkzeuge und Zubehör: siehe BIG KAISER Hauptkatalog

Präzisions-Ausdrehköpfe EWN, Serie 112, Ø 0,4 – 24,8 mm

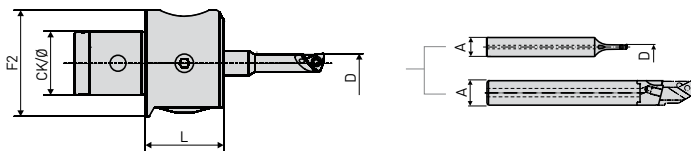

Ausdrehknopf	CK/Ø	D	A	L	F2
EWN 04-15	CK3/18	0,4-15,5	7	22	31
EWN 04-22	CK4/22	0,4-24,8	10	28	39

Siehe BIG KAISER Hauptkatalog Seite B51-55.
Abmessungen in mm

Präzisions-Ausdrehköpfe EWN, Serie 310, Ø 20 – 74 mm

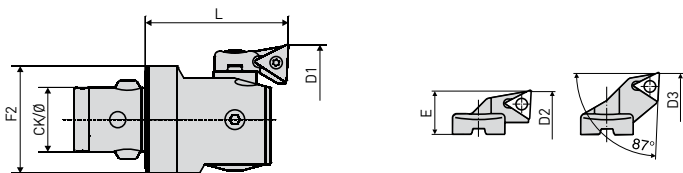

Ausdrehknopf	CK/Ø	D1	D2	D3	L	F2
EWN 20	CKB1/11	20-26	25-31	30-36	32,5	19
EWN 25	CKB2/14	25-33	32-40	39-47	35,5	24
EWN 32	CKB3/18	32-42	41-51	50-60	40	31
EWN 41	CKB4/22	41-54	50-63	61-74	47	39

Siehe BIG KAISER Hauptkatalog Seite B58-62.
Abmessungen in mm

Zweischneider-Ausdrehköpfe SW, Serie 319, Ø 20 – 66 mm

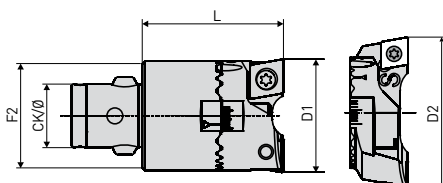

Ausdrehknopf	CK/Ø	D1	D2	L	F2
SW 20	CKB1/11	20-26	25-31	32,5	19
SW 25	CKB2/14	25-33	32-40	35,5	24
SW 32	CKB3/18	32-42	41-51	40	31
SW 41	CKB4/22	41-54	50-63	47	39

Siehe BIG KAISER Hauptkatalog Seite B27-31.
Abmessungen in mm

Rohling

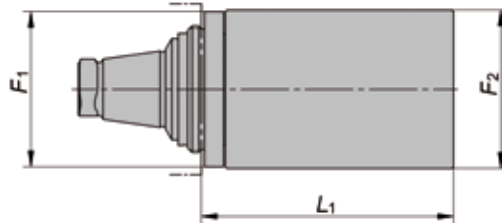

Größe	Bestellnummer	F ₁	F ₂	L ₁
ER-20QF	329020000	36	35	60
ER-25QF	329025000	49	50	80
ER-32QF	329032000	58	60	80
ER-40QF	329040000	71	70	100
ER-50QF	329050000	82	80	100

Abmessungen in mm

Schutzabdeckung

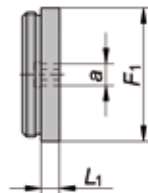

Größe	Bestellnummer	F ₁	L ₁	a
ER-20QF	337020000	33	6	6
ER-25QF	337025000	43	6	6
ER-32QF	337032000	52	10	8
ER-40QF	337040000	66	10	10
ER-50QF	337050000	76	10	12

Abmessungen in mm

Steilkegelaufnahme

DIN ISO 69871, für Voreinstellgeräte

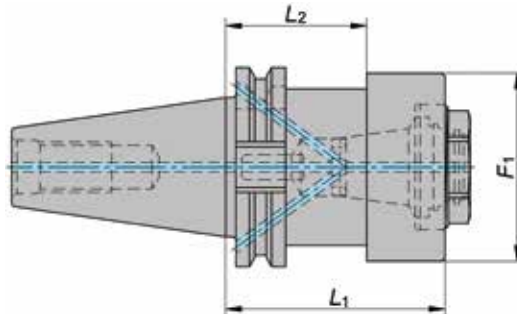



Größe	Bestellnummer	SK	F ₁	L ₁	L ₂	
ER-20QF	338120040	SK40	50	40	-	107520020
	338120050	SK50	50	40	-	107520020
ER-25QF	338125040	SK40	50	40	-	107525020
	338125050	SK50	50	40	-	107525020
ER-32QF	338132040	SK40	63	60	35	107532020
	338132050	SK50	63	60	-	107532020
ER-40QF	338140050	SK50	78	60	-	107540020
ER-50QF	338150050	SK50	85	60	35	107550020

Abmessungen in mm

HSK-Aufnahme

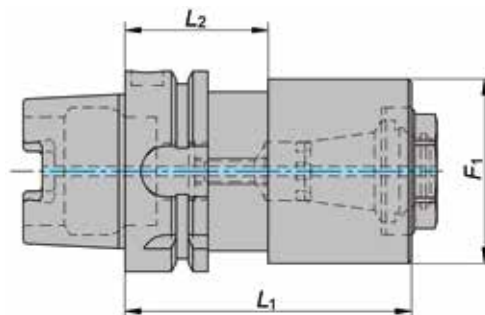
DIN 69893A/C (ISO 12164A/C), für Voreinstellgeräte



Größe	Bestellnummer	HSK	F ₁	L ₁	L ₂	
ER-20QF	338120063	HSK63A	50	85	-	107520020
ER-25QF	338125063	HSK63A	50	90	-	107525020
ER-32QF	338132063	HSK63A	63	90	42	107532020
ER-40QF	338140063	HSK63A	78	100	42	107540020
ER-50QF	338150063	HSK63A	85	120	42	107550020

Abmessungen in mm

Voreinstell-Adapter

Istmaße eingraviert

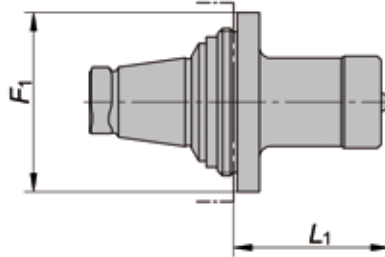

Größe	Bestellnummer	F ₁	L ₁
ER-20QF	339020000	36	42,25
ER-25QF	339025000	49	42,25
ER-32QF	339032000	58	45,25
ER-40QF	339040000	71	43,25
ER-50QF	339050000	82	45,25

Abmessungen in mm

Prüfdorn

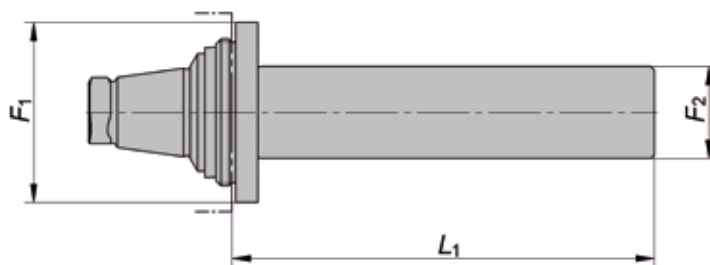



Größe	Bestellnummer	F ₁	F ₂	L ₁
ER-20QF	339120000	36	20	85
ER-25QF	339125000	49	25	115
ER-32QF	339132000	58	32	115
ER-40QF	339140000	71	32	115
ER-50QF	339150000	82	32	115

Abmessungen in mm. Inklusive Holzkiste

Montageblock QuickFlex®

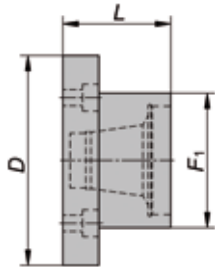
für den Werkzeugwechsel von QuickFlex® Adaptern auf der Werkbank



Größe	Bestellnummer	F1	L	D	
ER-20QF	338220000	45	45	87	107520020
ER-25QF	338225000	55	45	97	107525020
ER-32QF	338232000	65	60	107	107532020
ER-40QF	338240000	75	60	117	107540020
ER-50QF	338250000	86	80	127	107550020

Abmessungen in mm

Montagehilfe Toolboy (PWB Systems)

für den Werkzeugwechsel von QuickFlex®-Adaptern auf der Werkbank, schwenkbar



Modularer Einsatz QuickFlex®

passend für Montagehilfe Toolboy mit
Werkzeugaufnahmen:

- WTO 338200001
- PWB System 400141-8 (C8)



Größe	Bestellnummer	
ER-20QF	338220010	107520020
ER-25QF	338225010	107525020
ER-32QF	338232010	107532020
ER-40QF	338240010	107540020
ER-50QF	338250010	107550020

Werkzeugaufnahme

passend für Grundkörper:

- WTO 338200000
- PWB System 400500



Bestellnummer Werkzeugaufnahme
338200001

Grundkörper



Bestellnummer Grundkörper
338200000

Werkzeugträger

für QuickFlex®-Adapter (18 Stück)



Größe	Bestellnummer
ER-20QF	338320000
ER-25QF	338325000
ER-32QF	338332000
ER-40QF	338340000

BxHxT: 600x272x262 mm



Gewindespannring für QuickFlex®-Adapter

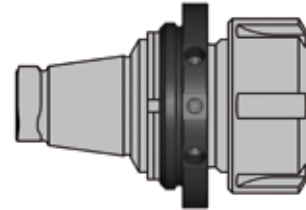
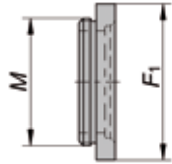

Größe	Bestellnummer	M	F ₁
ER-20QF	337120000	M 32 x 1,50	36
ER-25QF	337125000	M 40 x 1,50	49
ER-32QF	337132000	M 50 x 1,50	58
ER-40QF	337140000	M 62 x 1,50	71
ER-50QF	337150000	M 68 x 1,50	82

Abmessungen in mm

Haltering für QuickFlex®-Adapter

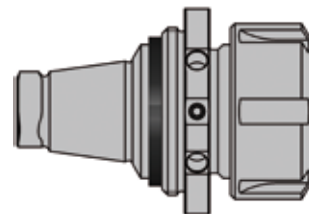

Größe	Bestellnummer
ER-20QF	337220000
ER-25QF	337225000
ER-32QF	337232000
ER-40QF	337240000
ER-50QF	337250000

Spannmutter ERQF

für interne Kühlmittelzufuhr Dichtscheiben verwenden
DIN 6499, ISO 15488

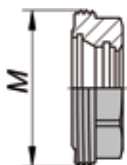



Größe	Bestellnummer	M	Nm	Dichtscheibe	
ER-20QF	207020000	M 32 x 1,50	80	210120...	107520020
ER-25QF	207025000	M 40 x 1,50	110	210125...	107525020
ER-32QF	207032000	M 50 x 1,50	140	210132...	107532020

Maximales Anzugsmoment in Nm beachten! Abmessungen in mm

Spannmutter ERQF-BC

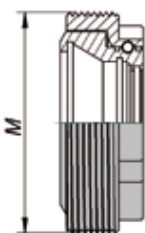
mit Kugellagerung, für interne Kühlmittelzufuhr Dichtscheiben verwenden
DIN 6499, ISO 15488



Größe	Bestellnummer	M	Nm	Dichtscheibe	
ER-40QF	208040001	M 62 x 1,50	180	210140...	107540020
ER-50QF	208050001	M 68 x 1,50	240	210150...	107550020

Maximales Anzugsmoment in Nm beachten! Abmessungen in mm

Spannmutter ERQF-A kurz

externe Kühlmittelzufuhr

DIN 6499, ISO 15488

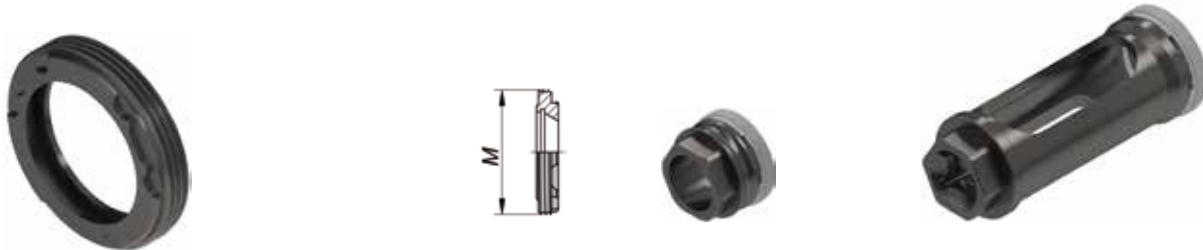

Größe	Bestellnummer	M	Nm						
ER-20QF	202120001	M 32 x 1,50	75	107525101	107525104	27	107525102	22	1/2"
ER-25QF	202125001	M 40 x 1,50	90	107532101	107532104	30	107532102	27	1/2"
ER-32QF	202132001	M 50 x 1,50	130	107540101	107540104	36	107540102	27	1/2"
ER-40QF	202140001	M 62 x 1,50	150	107540101	107540104	36	107540102	27	1/2"

Maximales Anzugsmoment in Nm beachten! Abmessungen in mm

Dichtscheiben für Spannmuttern

für interne Kühlmittelzufuhr



Bestellbeispiel:
210116040 ist passend für ER 16 und
einen Schaft d = 4,0 – 3,5

Größe	Bestellnummer Einzelne Scheiben	Bestellnummer kompletter Satz	d min.	d max.	Dichtbereich pro Scheibe	Anzahl pro Set	Lieferbare Dichtscheiben d
ER 16	210116...[d*10]	210116000	3,0	10	0,5	14	3,0-10
ER 20	210120...[d*10]	210120000	3,0	13	0,5	20	3,0-13
ER 25	210125...[d*10]	210125000	3,0	16	0,5	26	3,0-16
ER 32	210132...[d*10]	210132000	3,0	20	0,5	34	3,0-20
ER 40	210140...[d*10]	210140000	3,0	26	0,5	46	3,0-26

Abmessungen in mm

Einhandbedienschlüssel

für angetriebene Werkzeuge zum Gegenhalten der QuickFlex®-Spindel



Größe	Bestellnummer
20	107720000
25	107725000
32	107732000
40	107740000
50	107750000

Spannschlüssel

zum Spannen/Lösen von ERQF-Spannmuttern und QuickFlex®-Adaptern



Größe	Bestellnummer	Typ
ER-20QF	107520020	A
ER-25QF	107525020	A
ER-32QF	107532020	A
ER-40QF	107540020	B
ER-50QF	107550020	B

Drehmomentschlüssel

passend für alle Drehmomentadapter



Größe	Bestellnummer	Ø	Nm
ER-20QF bis ER-25QF	STW-D16-100-A	16	20 - 100
ER-32QF bis ER-50QF	STW-D16-200-A	16	40 - 200

Abmessungen in mm

Drehmomentadapter

zum Spannen von QuickFlex®-Adaptern



Größe	Bestellnummer	Nm ¹⁾
ER-20QF	107520021	65
ER-25QF	107525021	80
ER-32QF	107532021	100
ER-40QF	107540021	140
ER-50QF	107550021	160

mit Zapfenaufnahme Ø16

zum Spannen/Lösen von ERQF-Spannmuttern



Größe	Bestellnummer		Nm ¹⁾
ER-20QF	107520022	A	75
ER-25QF	107525022	A	100
ER-32QF	107532022	A	130
ER-40QF	107540022	B	165
ER-50QF	107550022	B	200

mit Zapfenaufnahme Ø16

zum Spannen/Lösen von ERQF-A-kurz-Spannmuttern



Größe	Bestellnummer	Nm ¹⁾
ER-25QF	107532105	85
ER-32QF	107540105	130
ER-40QF	107540105	130

mit Zapfenaufnahme Ø16

¹⁾ Einstellendes Drehmoment bei Verwendung des Drehmomentschlüssels STW-D16-...

Spannzangen Typ ER, hohe Präzision

DIN 6499B, ISO 15488

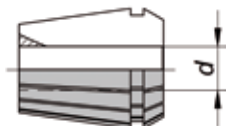

d	ER-11	ER-16	ER-20	ER-25	ER-32	ER-40	ER-50
1-0,5	190011010	190016010	190020010	190025010			
1,5-1	190011015						
2-1,5	190011020	190016020	190020020	190025020	190032020		
2,5-2	190011025						
3-2,5	190011030	190016030	190020030	190025030	190032030	190040030	
3,5-3	190011035						
4-3,5	190011040	190016040	190020040	190025040	190032040	190040040	
4,5-4	190011045						
5-4,5	190011050	190016050	190020050	190025050	190032050	190040050	190050060
5,5-5	190011055						
6-5,5	190011060	190016060	190020060	190025060	190032060	190040060	
6,5-6	190011065						
7-6,5	190011070	190016070	190020070	190025070	190032070	190040070	190050080
8-7		190016080	190020080	190025080	190032080	190040080	
9-8		190016090	190020090	190025090	190032090	190040090	190050100
10-9		190016100	190020100	190025100	190032100	190040100	
11-10			190020110	190025110	190032110	190040110	190050120
12-11			190020120	190025120	190032120	190040120	
13-12			190020130	190025130	190032130	190040130	190050140
14-13				190025140	190032140	190040140	
15-14				190025150	190032150	190040150	190050160
16-15				190025160	190032160	190040160	
17-16					190032170	190040170	190050180
18-17					190032180	190040180	
19-18					190032190	190040190	190050200
20-19					190032200	190040200	
21-20						190040210	190050220
22-21						190040220	
23-22						190040230	190050240
24-23						190040240	
25-24						190040250	190050260
26-25						190040260	
28-26							190050280
30-28							190050300
32-30							190050320
34-32							190050340

Abmessungen in mm. Rundlauf max. 0,01 mm

Kompletter Satz d	ER-11	ER-16	ER-20	ER-25	ER-32	ER-40	ER-50
7-0,5	190011000						
10-0,5		190016000					
13-1			190020000				
16-1				190025000			
20-2					190032000		
26-3						190040000	
34-10							190050000
Anzahl	13	10	12	15	18	23	12

Abmessungen in mm. Rundlauf max. 0,01 mm



Spannzangen Typ ER, Ultra-Präzision

DIN 6499B, ISO 15488

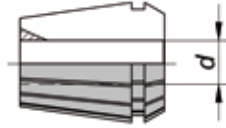

d	ER-11	ER-16	ER-20	ER-25	ER-32	ER-40	ER-50
1-0,5	190111010	190116010	190120010	190125010			
1,5-1	190111015						
2-1,5	190111020	190116020	190120020	190125020	190132020		
2,5-2	190111025						
3-2,5	190111030	190116030	190120030	190125030	190132030	190140030	
3,5-3	190111035						
4-3,5	190111040	190116040	190120040	190125040	190132040	190140040	
4,5-4	190111045						
5-4,5	190111050	190116050	190120050	190125050	190132050	190140050	
5,5-5	190111055						190150060
6-5,5	190111060	190116060	190120060	190125060	190132060	190140060	
6,5-6	190111065						
7-6,5	190111070	190116070	190120070	190125070	190132070	190140070	190150080
8-7		190116080	190120080	190125080	190132080	190140080	
9-8		190116090	190120090	190125090	190132090	190140090	
10-9		190116100	190120100	190125100	190132100	190140100	190150100
11-10			190120110	190125110	190132110	190140110	190150120
12-11			190120120	190125120	190132120	190140120	
13-12			190120130	190125130	190132130	190140130	190150140
14-13				190125140	190132140	190140140	
15-14				190125150	190132150	190140150	190150160
16-15				190125160	190132160	190140160	
17-16					190132170	190140170	190150180
18-17					190132180	190140180	
19-18					190132190	190140190	190150200
20-19					190132200	190140200	
21-20						190140210	190150220
22-21						190140220	
23-22						190140230	190150240
24-23						190140240	
25-24						190140250	190150260
26-25						190140260	
28-26							190150280
30-28							190150300
32-30							190150320
34-32							190150340

Abmessungen in mm. Rundlauf max. 0,005 mm

Kompletter Satz d	ER-11	ER-16	ER-20	ER-25	ER-32	ER-40	ER-50
7-0,5	190111000						
10-0,5		190116000					
13-1			190120000				
16-1				190125000			
20-2					190132000		
26-3						190140000	
34-10							190150000
Anzahl	13	10	12	15	18	23	12

Abmessungen in mm. Rundlauf max. 0,005 mm



Spannzangen Typ ER, hohe Präzision

mit Abdichtung für IK (max. 120 bar)

DIN 6499A, ISO 15488

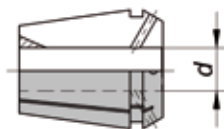

d	ER-11	ER-16	ER-20	ER-25	ER-32	ER-40
3	191011030	191016030	191020030	191025030	191032030	
4	191011040	191016040	191020040	191025040	191032040	
5	191011050	191016050	191020050	191025050	191032050	
6	191011060	191016060	191020060	191025060	191032060	191040060
7		191016070	191020070	191025070	191032070	
8		191016080	191020080	191025080	191032080	191040080
9		191016090	191020090	191025090	191032090	
10		191016100	191020100	191025100	191032100	191040100
11			191020110	191025110	191032110	
12			191020120	191025120	191032120	191040120
13				191025130	191032130	
14				191025140	191032140	191040140
15				191025150	191032150	
16				191025160	191032160	191040160
17					191032170	
18					191032180	191040180
19					191032190	
20					191032200	191040200
22						191040220
25						191040250

Spannbereich h8
(nur Nennmaß)

Abmessungen in mm. Rundlauf max. 0,01 mm

Kompletter Satz mm	ER-16	ER-20	ER-25	ER-32
10, 8, 6, 5, 4, 3	191016000			
12, 10, 8, 6, 5, 4, 3		191020000		
16, 14, 12, 10, 8, 6, 4			191025000	
20, 16, 14, 12, 10, 8, 6, 4				191032000
Anzahl	6	7	7	8

Abmessungen in mm. Rundlauf max. 0,01 mm



Spannzangen Typ ER, Ultra-Präzision

Metallisch dichtend für IK (max. 120 bar)

DIN 6499B, ISO 15488

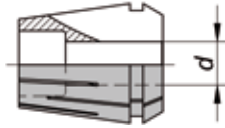

d	ER-11	ER-16	ER-20	ER-25	ER-32
3	191111030	191116030 ¹⁾	191120030 ¹⁾		
4	191111040	191116040 ¹⁾	191120040 ¹⁾		
5	191111050	191116050	191120050 ¹⁾		
6	191111060	191116060	191120060 ¹⁾	191125060 ¹⁾	191132060 ¹⁾
7	191111070	191116070	191120070	191125070 ¹⁾	191132070 ¹⁾
8		191116080	191120080	191125080	191132080
9		191116090	191120090	191125090	191132090
10		191116100	191120100	191125100	191132100
11			191120110	191125110	191132110
12			191120120	191125120	191132120
13			191120130	191125130	191132130
14				191125140	191132140
15				191125150	191132150
16				191125160	191132160
17					191132170
18					191132180
19					191132190
20					191132200

Abmessungen in mm. Rundlauf max. 0,006 mm

Minimaler Spanndurchmesser:

ER-11: $d_{\min} = d - 0,25$ mm

ER-16 to ER-32: $d_{\min} = d - 0,5$ mm

¹⁾ $d_{\min} = d \text{ h}9$

Kompletter Satz mm	ER-16	ER-20	ER-25	ER-32
10-3	191116000			
13-3		191120000		
16-6			191125000	
20-6				191132001
Anzahl	8	11	6	8

Abmessungen in mm. Rundlauf max. 0,006 mm



Schrumpfspannzangen Typ TER

für innere Kühlmittelzufuhr (max. 200 bar) geeignet
DIN 6499, ISO 15488

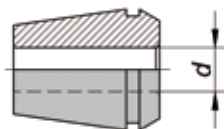

d	ER-11	ER-16	ER-20	ER-25	ER-32
3	192011030	192016030	192020030	192025030	
4	192011040	192016040	192020040	192025040	
6	192011060	192016060	192020060	192025060	192032060
8		192016080	192020080	192025080	192032080
10			192020100 ¹⁾	192025100	192032100
12				192025120	192032120
14				192025140 ¹⁾	192032140
16				192025160 ¹⁾	192032160
18					192032180 ¹⁾
20					192032200 ¹⁾

Abmessungen in mm. Rundlauf max. 0,003 mm

Toleranz Werkzeugschaftdurchmesser
mindestens h6, oder niedriger.

¹⁾ Nur einsetzbar mit kurzer Spannmutter ERQF-A:



Hinweis:

Damit der zylindrische Werkzeugschaft sicher und präzise im Adapter montiert werden kann, müssen Verschmutzungen und Grate entfernt werden.

Schrumpfgeräte

Die TER-Schrumpfspannzangen funktionieren durch Erhitzung zur Aufweitung der Spannzange. Bei Kühlung zieht sich der Adapter zusammen und umschließt so den Werkzeugschaft. Für eine perfekte Funktionsweise, optimale Werkzeugleistung und sichere, einfache Handhabung der Spannfunktion müssen die Induktionsgeräte ThermoGrip® eingesetzt und die Gebrauchsanleitung befolgt werden. Weitere Informationen unter www.diebold-hsk.de oder www.bilz.com.

Gewindebohrzange Typ ER GB

ohne Längenausgleich
DIN 6499A, ISO 15488

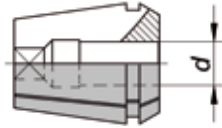

d ø	d □	ER-11-GB	ER-16-GB	ER-20-GB	ER-25-GB	ER-32-GB	ER-40-GB	ER-50-GB
2,8	2,1	181011028	181016028					
3,5	2,7	181011035	181016035	181020035	181025035			
4	3,15/3,2	181011040	181016040	181020040	181025040	181032040		
4,5	3,4	181011045	181016045	181020045	181025045	181032045		
5	4	181011050	181016050	181020050	181025050	181032050		
5,5	4,3		181016055	181020055	181025055	181032055		
6	4,9	181011060	181016060	181020060	181025060	181032060	181040060	
6,2	5		181016062	181020062	181025062	181032062	181040062	
6,3	5		181016063	181020063	181025063	181032063	181040063	
7	5,5		181016070	181020070	181025070	181032070	181040070	
7,1	5,6		181016071	181020071	181025071	181032071	181040071	
8	6,2/6,3		181016080	181020080	181025080	181032080	181040080	
8,5	6,5		181016085	181020085	181025085	181032085	181040085	
9	7/7,1		181016090	181020090	181025090	181032090	181040090	
10	8			181020100	181025100	181032100	181040100	
10,5	8			181020105	181025105	181032105	181040105	
11	9			181020110	181025110	181032110	181040110	
11,2	9			181020112	181025112	181032112	181040112	
12	9			181020120	181025120	181032120	181040120	
12,5	10				181025125	181032125	181040125	
14	11/11,2				181025140	181032140	181040140	
15	12				181025150	181032150	181040150	
16	12/12,5				181025160	181032160	181040160	
17	13					181032170	181040170	
18	14/14,5					181032180	181040180	
20	16					181032200	181040200	
22	18						181040220	181050220
25	20						181040250	181050250
28	22							181050280
32	24							181050320

Abmessungen in mm. Rundlauf max. 0,01 mm



Qualität ohne Kompromisse.

Jeder einzelne Prozessschritt ist auf höchste Perfektion ausgelegt.

Bei der Herstellung unserer Präzisionswerkzeughalter gehen wir von der technischen Auslegung bis zur Erstellung des fertigen Produktes keine Kompromisse ein.

Um den hohen Qualitätsstandard sicher zu stellen, prüfen wir jeden Fertigungsschritt bis zum fertigen Produkt. Jedes Endprodukt wird auf hochgenauen 3D-Koordinaten-Messmaschinen vermessen.

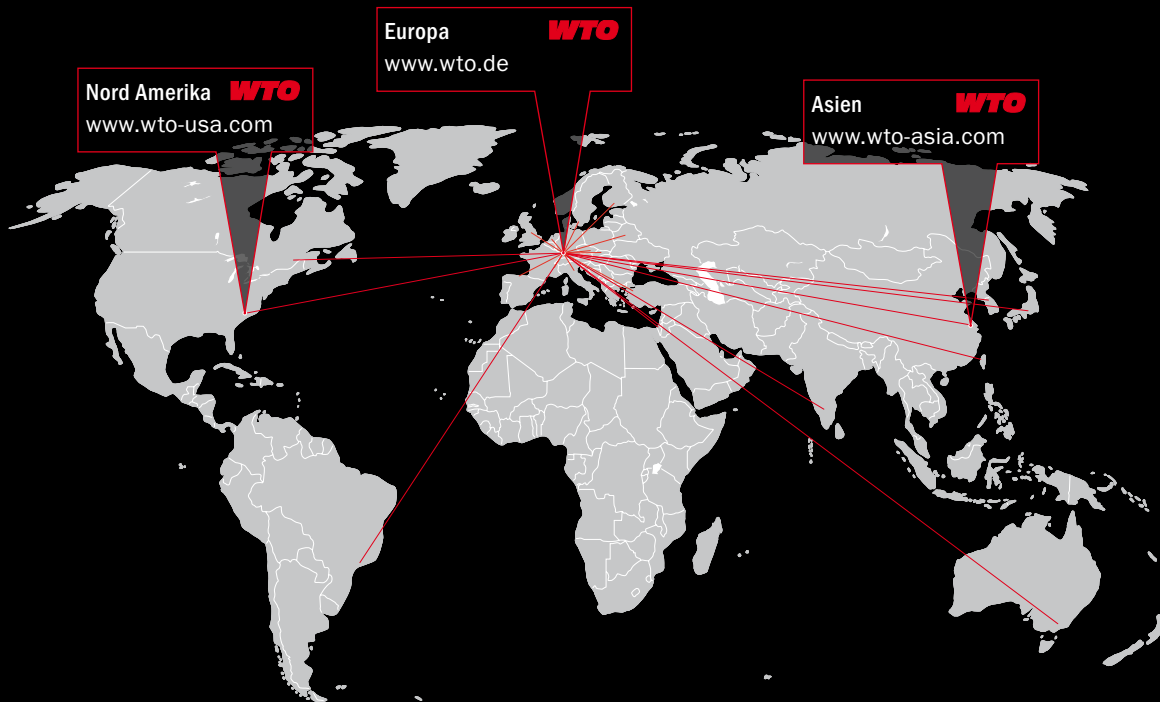

WTO Werkzeug-
Einrichtungen GmbH
Neuer Hohdammweg 1
77797 Ohlsbach
Deutschland

WTO Inc.
13900-F South Lakes Dr.
Charlotte, NC 28273
USA

WTO Asia
WTO Precision Tool Holders
(Shanghai) Co. Ltd.
Room 109-110, Building 2
No. 228 Banting Road
Jiuting Town,
Songjiang District
201615 Shanghai
China

Vertriebspartner – Kompetente Beratung vor Ort

Australien
Dimac Tooling Ltd.
sales@dimac.com.au

Großbritannien
Cutwel Ltd.
sales@cutwel.net

Mexiko
Workholding Engineering De México
info@wem.com.mx

Slowakei
ALBA precision s.r.o.
albabprecision@albabprecision.sk

Brasilien
TF2
tfdois@tfdois.com.br

Indien
Ulhas Patil
u.patil@wto-asia.com

Niederlande
Toologic BeNeLux B.V.
info@toologic-benelux.nl

Spanien
ITALMATIC, S.A.
italmatic@italmatic.es

China
Shanghai Gangde
wtocando@yahoo.com

Israel
E.Y.A.R. Ltd.
boris@eyar.co.il

Norwegen
Helge Karlsen Verktøy og Maskin AS
hkvm@hkvm.no

Taiwan
Kaiko Co., Ltd.
info@kaiko.com.tw

Dänemark
AVN Teknik A/S
cjo@avn.dk

Italien
Prymark srl
commerciale@prymark.it

Polen
ARCO Andrzej Rudenko
info@arcotools.pl

Türkei
MYK CNC MAKINA SAN. VE
huseyin.tatlidil@mykcnc.com.tr

Finnland
Suomen Terästuonti Oy
myynti@stt.as

Japan
NK Works Co. Ltd.
k_samba@nk-works.co.jp

Rumänien
SC Elif Trading SRL
bulent.ozkan@eliftrading.com

Tschechien
ALBA precision, spol. s.r.o.
info@albabprecision.cz

Frankreich Ost
Christophe Archambault
alm@wto.de

Kanada
Mittmann Industrial Inc.
info@mittmann.com

Schweden
Bonhron & Ewing AB
info@bonhron-ewing.se

Ukraine
„LLC“ SPA Stankopromimport
info@phoenix-ua.com

Frankreich West
Christophe Archambault
car@wto.de

Korea
WTO Office Korea
is.chon@wto-korea.com

Schweiz
Utilis AG
info@utilis.com

Ungarn
Prevotex Hungary Kft.
info@prevotex.hu